

# NST847BF3T5G

## NPN General Purpose Transistor

The NST847BF3T5G device is a spin-off of our popular SOT-23/SOT-323/SOT-563/SOT-963 three-lead device. It is designed for general purpose amplifier applications and is housed in the SOT-1123 surface mount package. This device is ideal for low-power surface mount applications where board space is at a premium.

### Features

- $h_{FE}$ , 200–450
- Low  $V_{CE(sat)}$ ,  $\leq 0.25$  V
- Reduces Board Space
- This is a Pb-Free Device

### MAXIMUM RATINGS

Rating	Symbol	Value	Unit
Collector – Emitter Voltage	$V_{CEO}$	45	Vdc
Collector – Base Voltage	$V_{CBO}$	50	Vdc
Emitter – Base Voltage	$V_{EBO}$	6.0	Vdc
Collector Current – Continuous	$I_C$	100	mAdc

### THERMAL CHARACTERISTICS

Characteristic	Symbol	Max	Unit
Total Device Dissipation, $T_A = 25^\circ\text{C}$ Derate above $25^\circ\text{C}$	$P_D$ (Note 1)	290 2.3	mW mW/ $^\circ\text{C}$
Thermal Resistance, Junction-to-Ambient	$R_{\theta JA}$ (Note 1)	432	$^\circ\text{C}/\text{W}$
Total Device Dissipation, $T_A = 25^\circ\text{C}$ Derate above $25^\circ\text{C}$	$P_D$ (Note 2)	347 2.8	mW mW/ $^\circ\text{C}$
Thermal Resistance, Junction-to-Ambient	$R_{\theta JA}$ (Note 2)	360	$^\circ\text{C}/\text{W}$
Thermal Resistance, Junction-to-Lead 3	$R_{\theta JL}$ (Note 2)	143	$^\circ\text{C}/\text{W}$
Junction and Storage Temperature Range	$T_J, T_{stg}$	-55 to +150	$^\circ\text{C}$

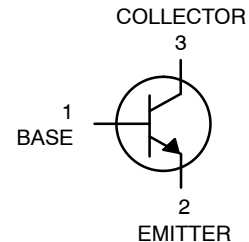
Stresses exceeding Maximum Ratings may damage the device. Maximum Ratings are stress ratings only. Functional operation above the Recommended Operating Conditions is not implied. Extended exposure to stresses above the Recommended Operating Conditions may affect device reliability.

1. 100 mm<sup>2</sup> 1 oz, copper traces.
2. 500 mm<sup>2</sup> 1 oz, copper traces.

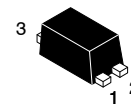


**ON Semiconductor®**

<http://onsemi.com>

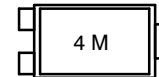


NST847BF3T5G



SOT-1123  
CASE 524AA  
STYLE 1

### MARKING DIAGRAM



4 = Device Code  
M = Date Code

### ORDERING INFORMATION

Device	Package	Shipping†
NST847BF3T5G	SOT-1123 (Pb-Free)	8000/Tape & Reel

†For information on tape and reel specifications, including part orientation and tape sizes, please refer to our Tape and Reel Packaging Specifications Brochure, BRD8011/D.

# NST847BF3T5G

## ELECTRICAL CHARACTERISTICS (T<sub>A</sub> = 25°C unless otherwise noted)

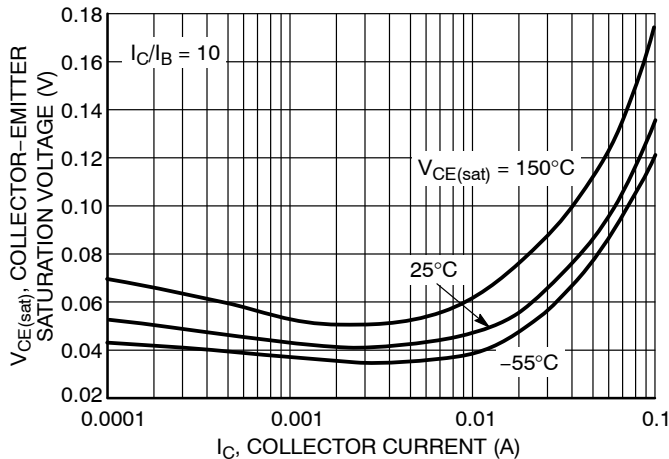
Characteristic	Symbol	Min	Typ	Max	Unit
<b>OFF CHARACTERISTICS</b>					
Collector–Emitter Breakdown Voltage (I <sub>C</sub> = 10 mA)	V <sub>(BR)CEO</sub>	45	–	–	V
Collector–Emitter Breakdown Voltage (I <sub>C</sub> = 10 μA, V <sub>EB</sub> = 0)	V <sub>(BR)CES</sub>	50	–	–	V
Collector–Base Breakdown Voltage (I <sub>C</sub> = 10 μA)	V <sub>(BR)CBO</sub>	50	–	–	V
Emitter–Base Breakdown Voltage (I <sub>E</sub> = 1.0 μA)	V <sub>(BR)EBO</sub>	6.0	–	–	V
Collector Cutoff Current (V <sub>CB</sub> = 30 V) (V <sub>CB</sub> = 30 V, T <sub>A</sub> = 150°C)	I <sub>CBO</sub>	–	–	15 5.0	nA μA

## ON CHARACTERISTICS

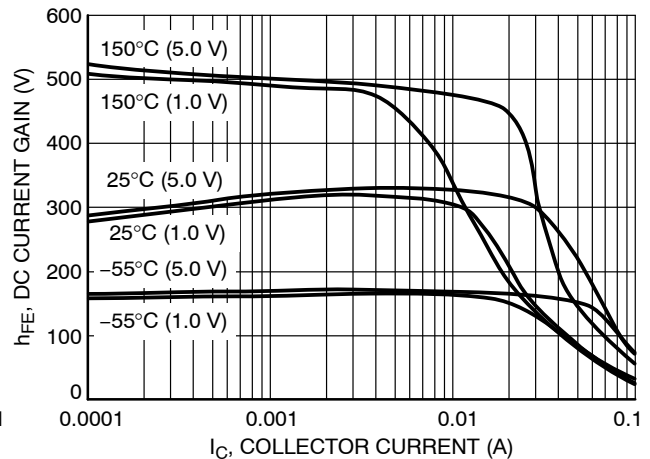
DC Current Gain (I <sub>C</sub> = 10 μA, V <sub>CE</sub> = 5.0 V) (I <sub>C</sub> = 2.0 mA, V <sub>CE</sub> = 5.0 V)	h <sub>FE</sub>	– 200	150 290	– 450	–
Collector–Emitter Saturation Voltage (I <sub>C</sub> = 10 mA, I <sub>B</sub> = 0.5 mA) (I <sub>C</sub> = 100 mA, I <sub>B</sub> = 5.0 mA)	V <sub>CE(sat)</sub>	– –	– –	0.25 0.6	V
Base–Emitter Saturation Voltage (I <sub>C</sub> = 10 mA, I <sub>B</sub> = 0.5 mA) (I <sub>C</sub> = 100 mA, I <sub>B</sub> = 5.0 mA)	V <sub>BE(sat)</sub>	– –	0.7 0.9	– –	V
Base–Emitter Voltage (I <sub>C</sub> = 2.0 mA, V <sub>CE</sub> = 5.0 V) (I <sub>C</sub> = 10 mA, V <sub>CE</sub> = 5.0 V)	V <sub>BE(on)</sub>	580 –	660 –	700 770	mV

## SMALL–SIGNAL CHARACTERISTICS

Current–Gain–Bandwidth Product (I <sub>C</sub> = 10 mA, V <sub>CE</sub> = 5.0 Vdc, f = 100 MHz)	f <sub>T</sub>	100	–	–	MHz
Output Capacitance (V <sub>CB</sub> = 10 V, f = 1.0 MHz)	C <sub>obo</sub>	–	–	4.5	pF
Input Capacitance (V <sub>EB</sub> = 0.5 V, I <sub>C</sub> = 0 mA, f = 1.0 MHz)	C <sub>ibo</sub>	–	–	10	pF
Noise Figure (I <sub>C</sub> = 0.2 mA, V <sub>CE</sub> = 5.0 Vdc, R <sub>S</sub> = 2.0 kΩ, f = 1.0 kHz, BW = 200 Hz)	NF	–	–	10	dB

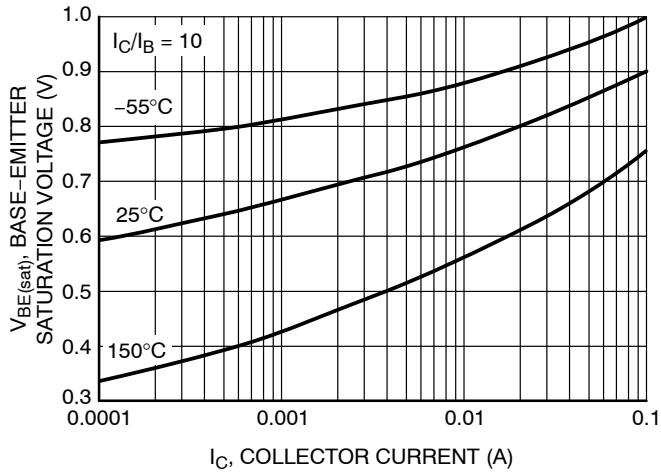


**Figure 1. Collector Emitter Saturation Voltage vs. Collector Current**

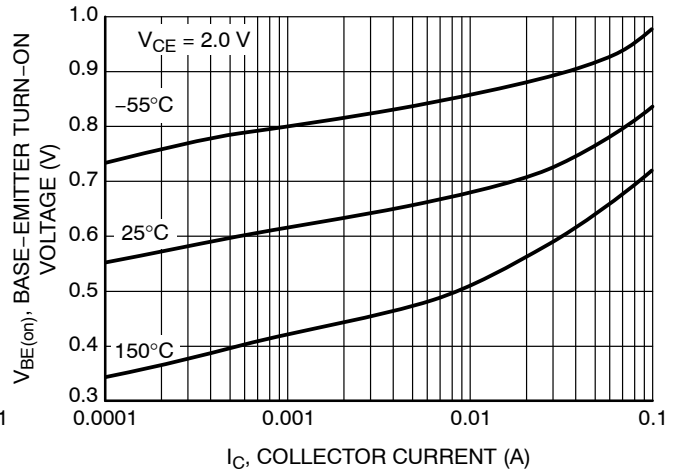


**Figure 2. DC Current Gain vs. Collector Current**

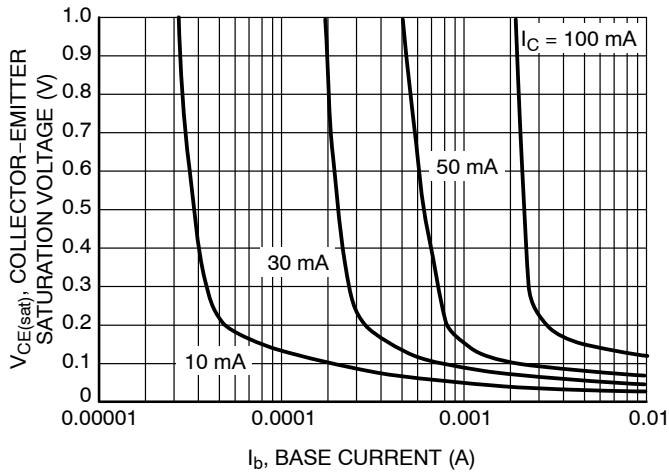
# NST847BF3T5G



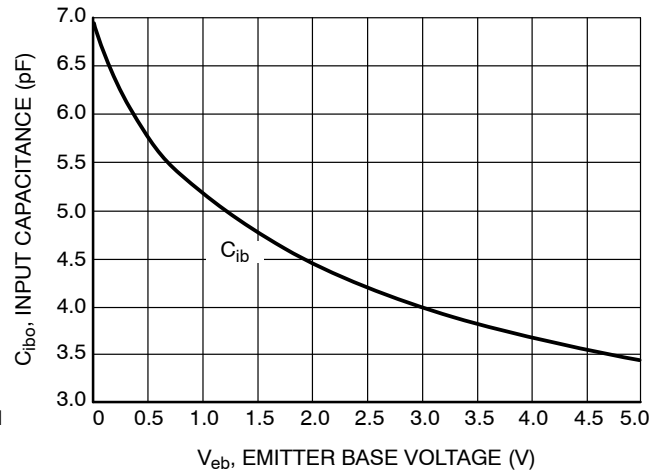
**Figure 3. Base Emitter Saturation Voltage vs. Collector Current**



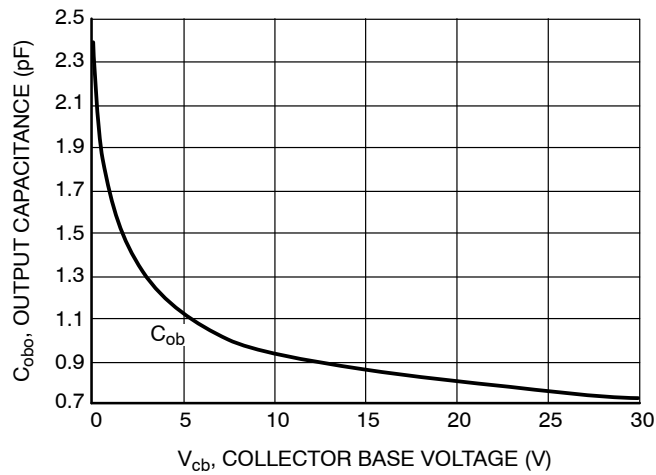
**Figure 4. Base Emitter Turn-On Voltage vs. Collector Current**



**Figure 5. Saturation Region**



**Figure 6. Input Capacitance**

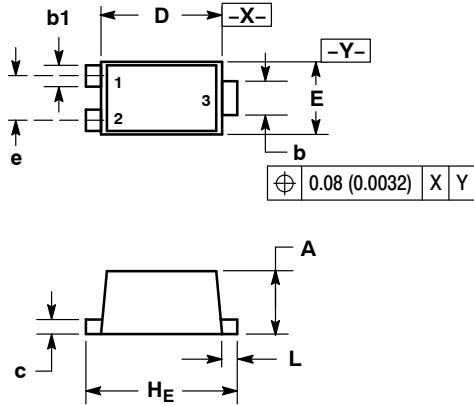


**Figure 7. Output Capacitance**

# NST847BF3T5G

## PACKAGE DIMENSIONS

SOT-1123  
CASE 524AA-01  
ISSUE A

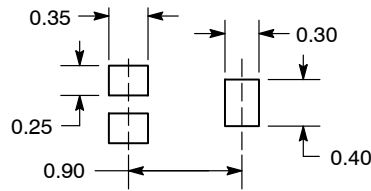


- NOTES:
1. DIMENSIONING AND TOLERANCING PER ANSI Y14.5M, 1982.
  2. CONTROLLING DIMENSION: MILLIMETERS.
  3. MAXIMUM LEAD THICKNESS INCLUDES LEAD FINISH THICKNESS. MINIMUM LEAD THICKNESS IS THE MINIMUM THICKNESS OF BASE MATERIAL.

DIM	MILLIMETERS			INCHES		
	MIN	NOM	MAX	MIN	NOM	MAX
A	0.34	0.37	0.40	0.013	0.015	0.016
b	0.15	0.20	0.25	0.006	0.008	0.010
b1	0.10	0.15	0.20	0.004	0.006	0.008
c	0.07	0.12	0.17	0.003	0.005	0.007
D	0.75	0.80	0.85	0.030	0.031	0.033
E	0.55	0.60	0.65	0.022	0.024	0.026
e	0.35			0.014		
HE	0.95	1.00	1.05	0.037	0.039	0.041
L	0.05	0.10	0.15	0.002	0.004	0.006

STYLE 1:  
PIN 1. BASE  
2. EMITTER  
3. COLLECTOR

### SOLDERING FOOTPRINT\*



DIMENSIONS: MILLIMETERS

\*For additional information on our Pb-Free strategy and soldering details, please download the ON Semiconductor Soldering and Mounting Techniques Reference Manual, SOLDERRM/D.

ON Semiconductor and are registered trademarks of Semiconductor Components Industries, LLC (SCILLC). SCILLC reserves the right to make changes without further notice to any products herein. SCILLC makes no warranty, representation or guarantee regarding the suitability of its products for any particular purpose, nor does SCILLC assume any liability arising out of the application or use of any product or circuit, and specifically disclaims any and all liability, including without limitation special, consequential or incidental damages. "Typical" parameters which may be provided in SCILLC data sheets and/or specifications can and do vary in different applications and actual performance may vary over time. All operating parameters, including "Typicals" must be validated for each customer application by customer's technical experts. SCILLC does not convey any license under its patent rights nor the rights of others. SCILLC products are not designed, intended, or authorized for use as components in systems intended for surgical implant into the body, or other applications intended to support or sustain life, or for any other application in which the failure of the SCILLC product could create a situation where personal injury or death may occur. Should Buyer purchase or use SCILLC products for any such unintended or unauthorized application, Buyer shall indemnify and hold SCILLC and its officers, employees, subsidiaries, affiliates, and distributors harmless against all claims, costs, damages, and expenses, and reasonable attorney fees arising out of, directly or indirectly, any claim of personal injury or death associated with such unintended or unauthorized use, even if such claim alleges that SCILLC was negligent regarding the design or manufacture of the part. SCILLC is an Equal Opportunity/Affirmative Action Employer. This literature is subject to all applicable copyright laws and is not for resale in any manner.

### PUBLICATION ORDERING INFORMATION

**LITERATURE FULFILLMENT:**  
Literature Distribution Center for ON Semiconductor  
P.O. Box 5163, Denver, Colorado 80217 USA  
**Phone:** 303-675-2175 or 800-344-3860 Toll Free USA/Canada  
**Fax:** 303-675-2176 or 800-344-3867 Toll Free USA/Canada  
**Email:** orderlit@onsemi.com

**N. American Technical Support:** 800-282-9855 Toll Free  
USA/Canada  
**Europe, Middle East and Africa Technical Support:**  
Phone: 421 33 790 2910  
**Japan Customer Focus Center**  
Phone: 81-3-5773-3850

**ON Semiconductor Website:** [www.onsemi.com](http://www.onsemi.com)

**Order Literature:** <http://www.onsemi.com/orderlit>

For additional information, please contact your local Sales Representative